

gesamt: 734,23 m²

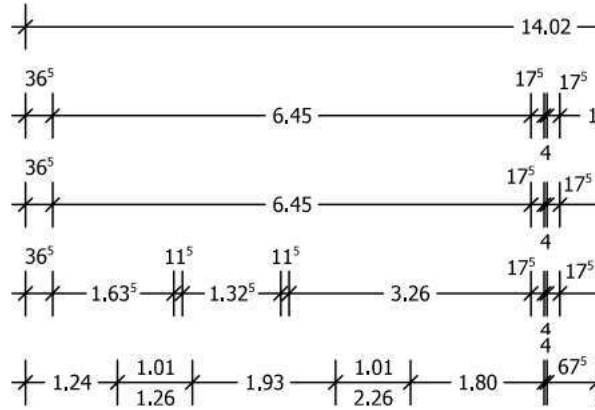

meinfläche:
3,0m x 3,0m = 87,30 m²

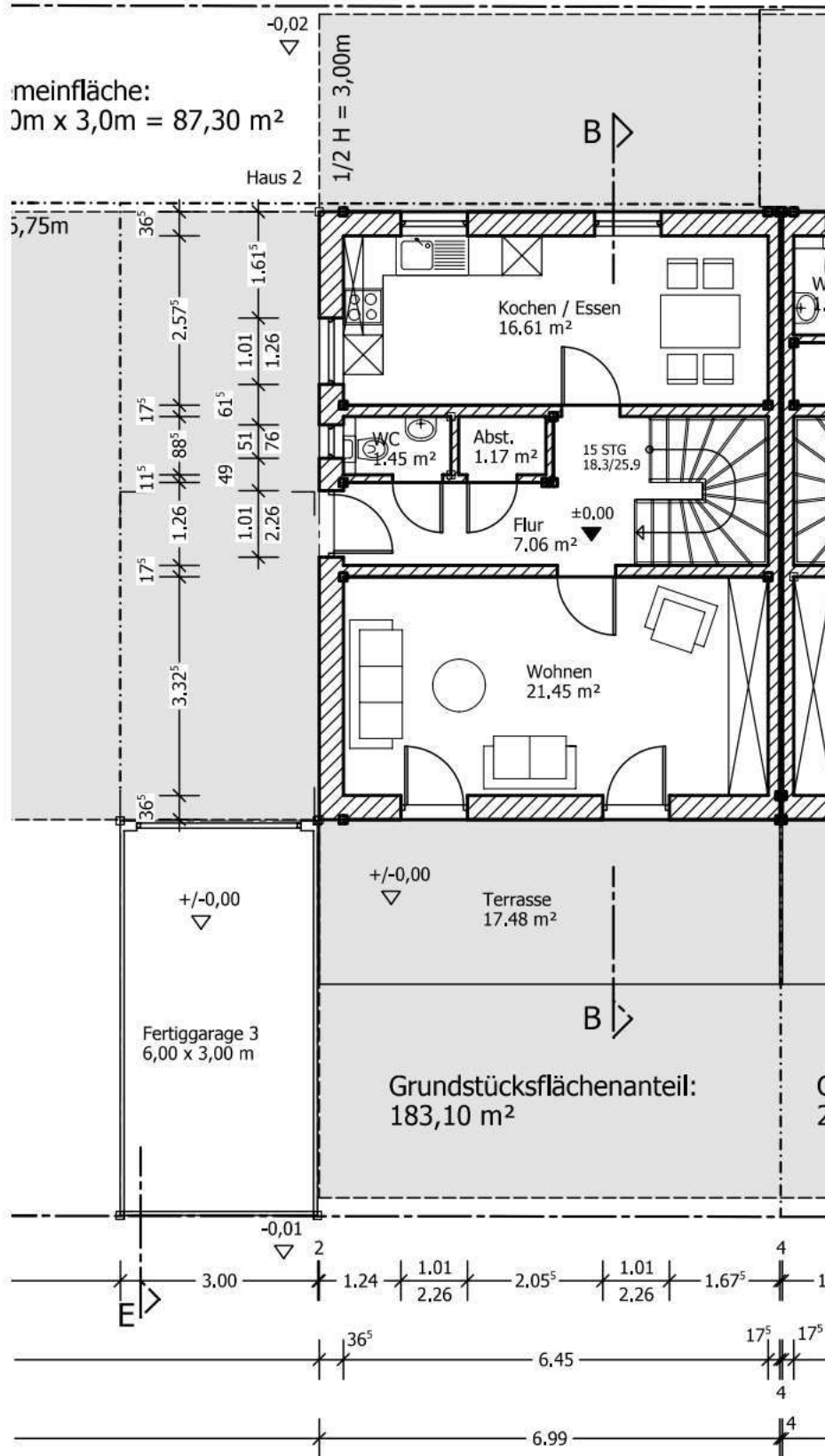

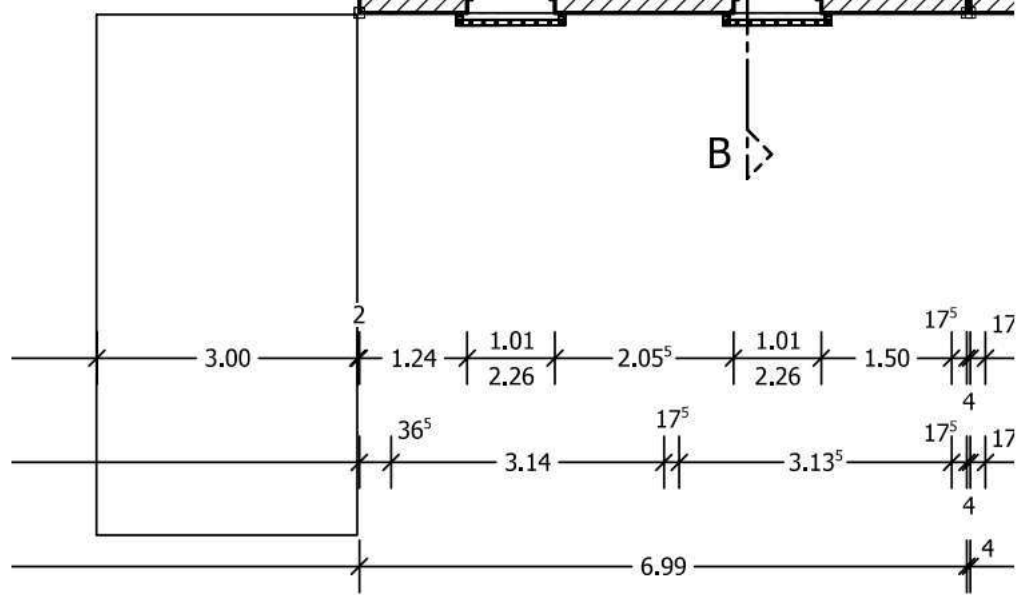
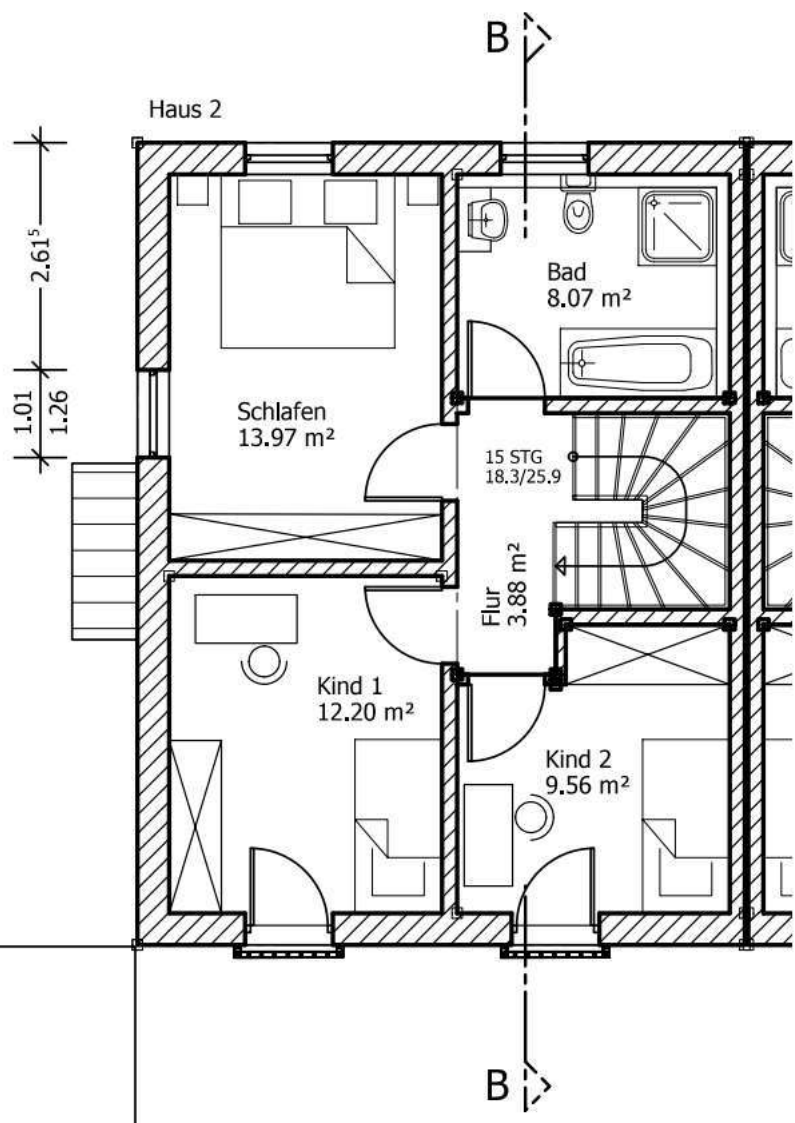
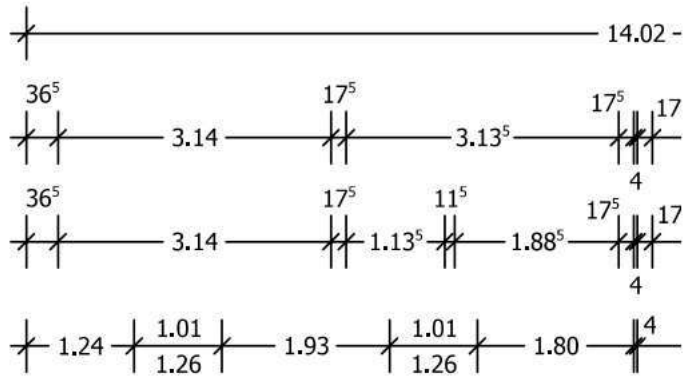

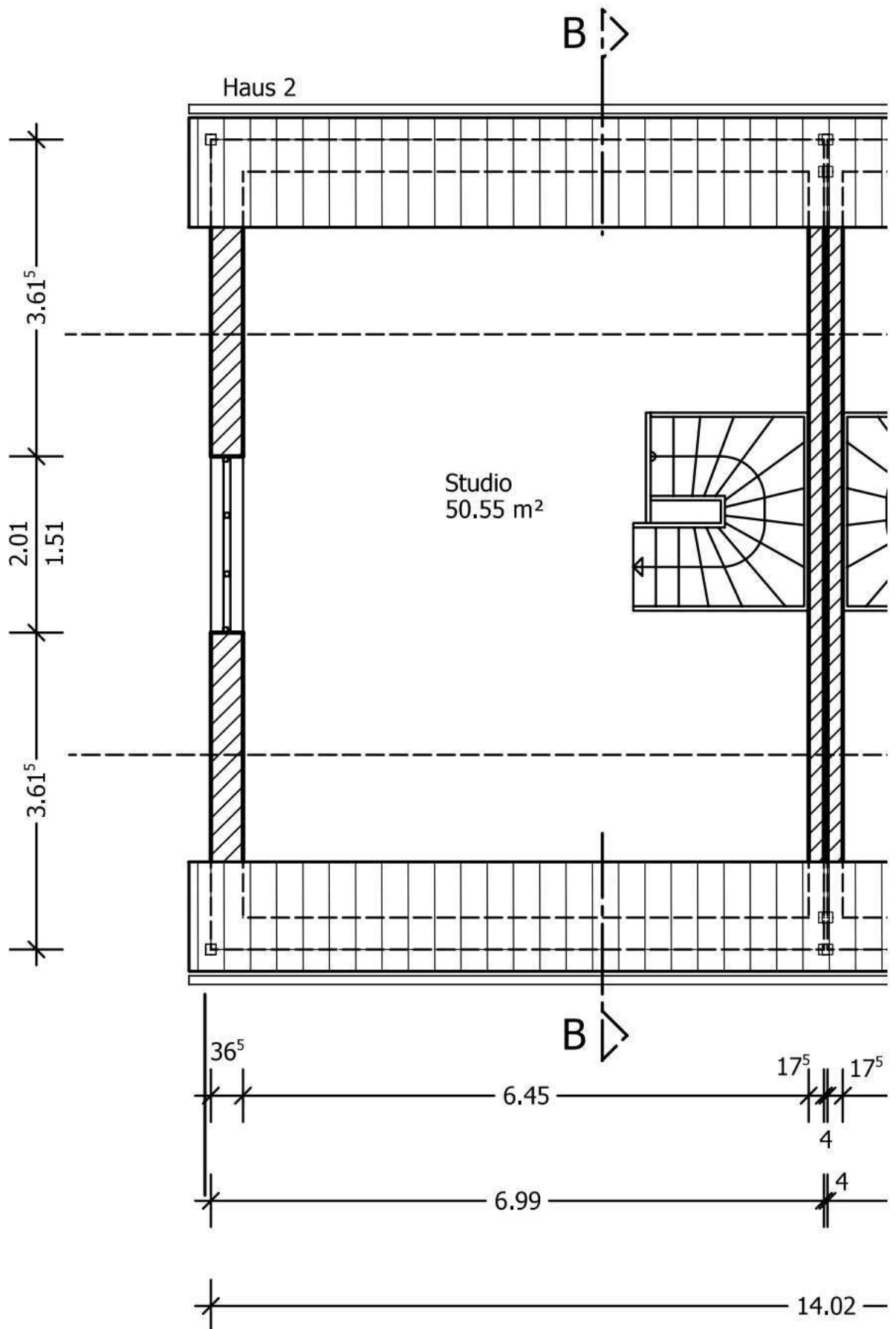

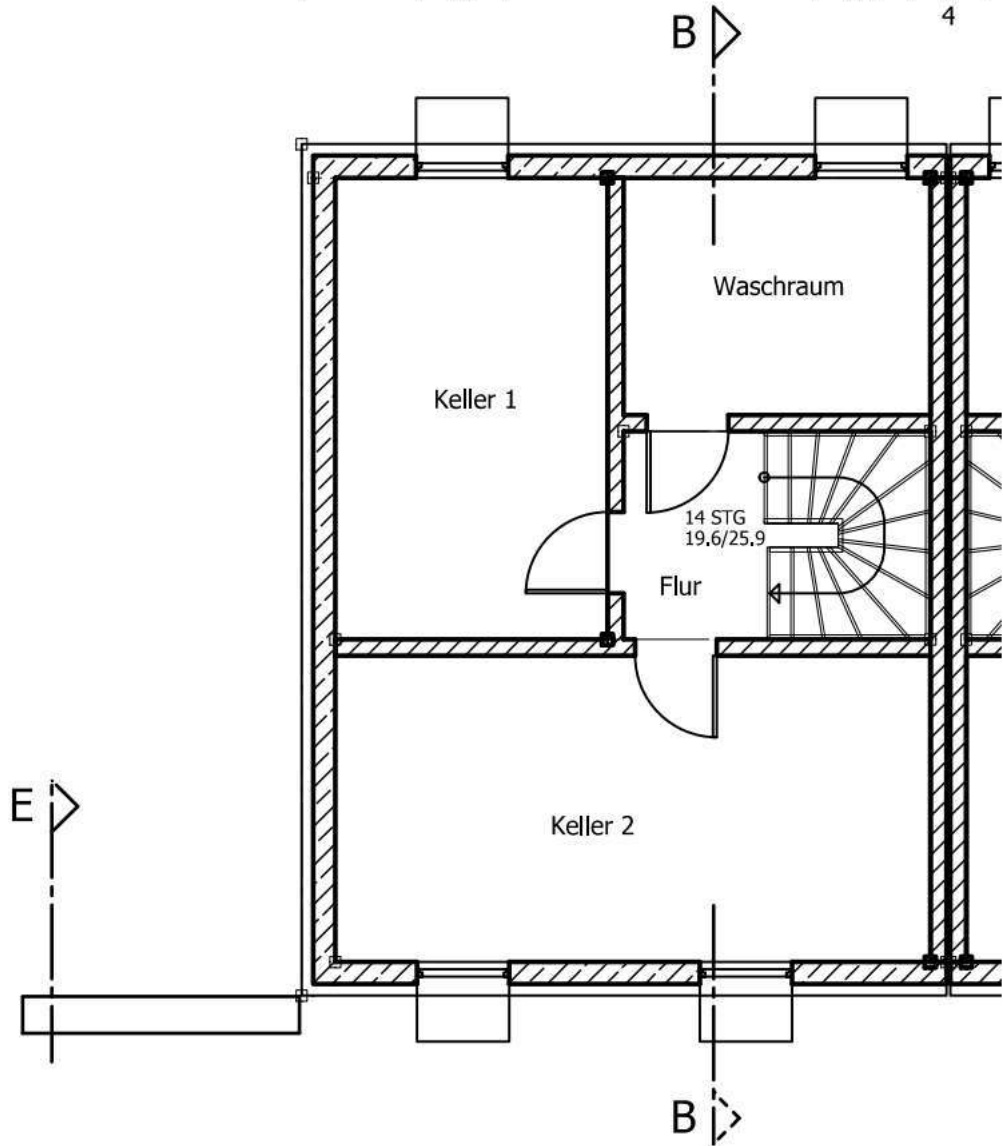
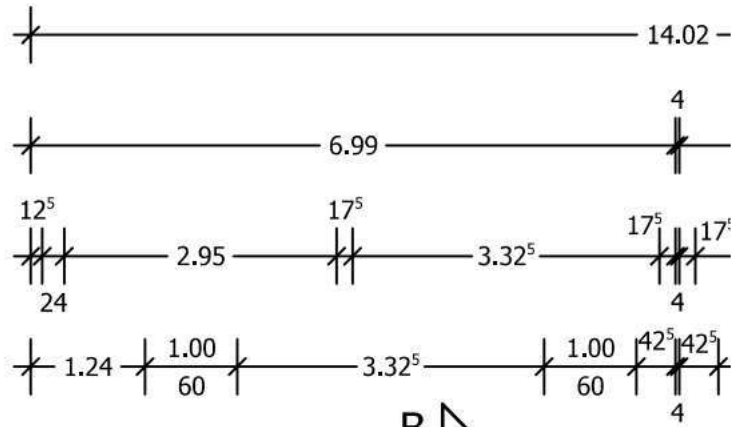

nte für Fertiggaragen
berechnung

